

MANISCOPIC

Equipments

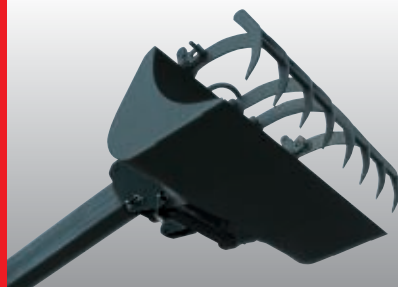

MANITOU

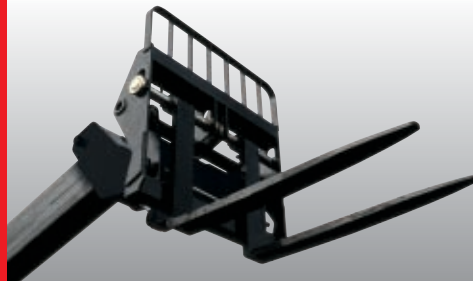
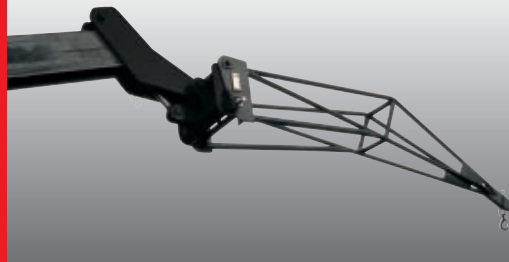
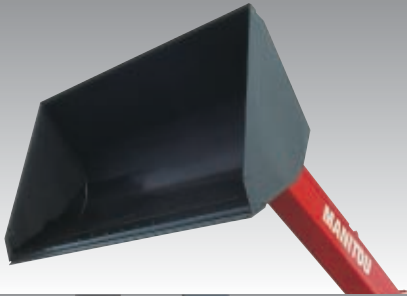
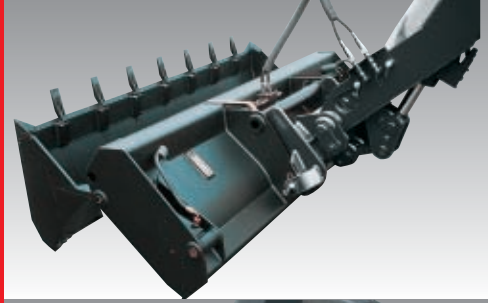





Agriculture

BUCKET

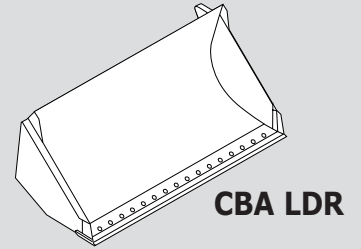
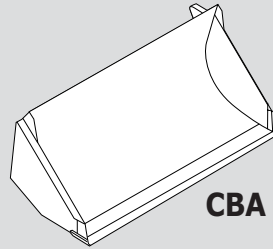

BUCKET WITH GRAB

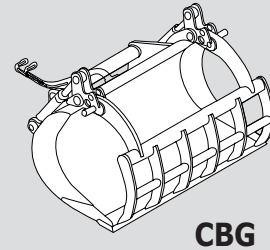

MANURE FORKS (with and without grab)

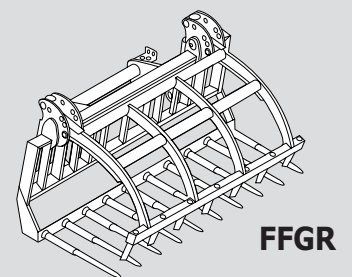
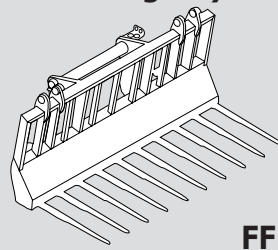

BALE FORK (square bales)

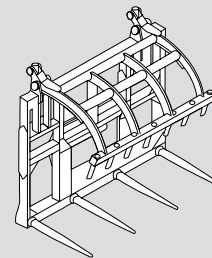

BALE CLAMP (round or wrapped bales)

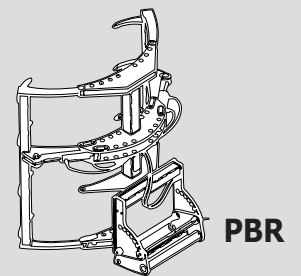
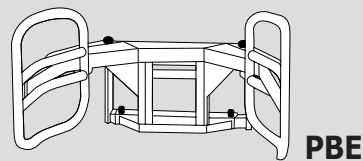

SILAGE UNLOADER & DISTRIBUTOR

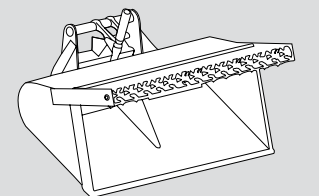
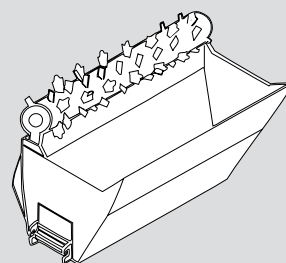

FRAME LEVELLER

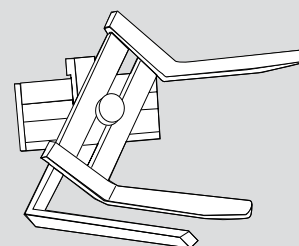





Construction - Public works

BUCKETS

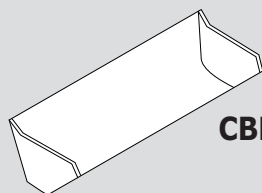

CBR

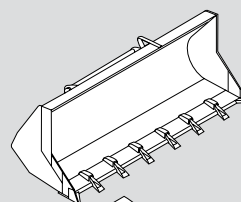

CBC

"4X1" multipurpose bucket

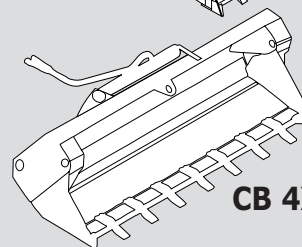

CB 4X1

CONCRETE SKIPS

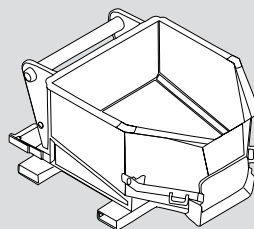

BB/BBH

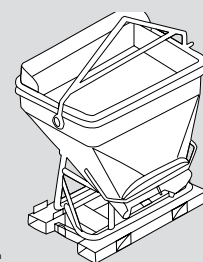

GL

CONCRETE MIXER BUCKET

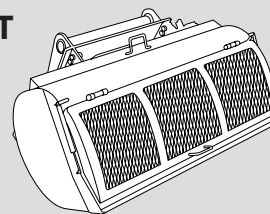

JIBS
(with or without winch)

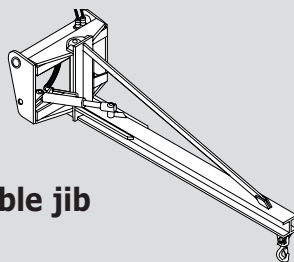

Adjustable jib

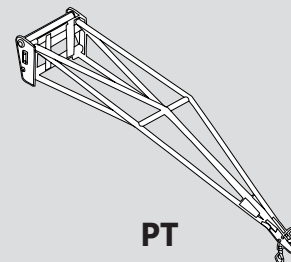

PT

EXTRA LIFT MAST

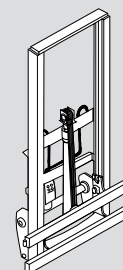

RS

FLOATING FORKS

Frame leveller 10°/10°

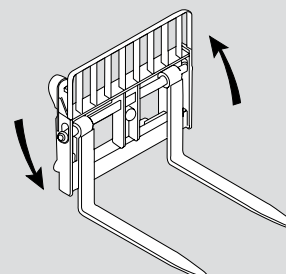





Industry

WOOD CLAMPS AND GRABS

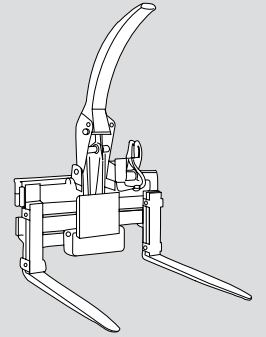
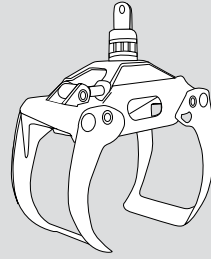
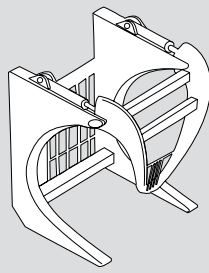

FORK MOUNTED ADJUSTABLE HOOK JIB

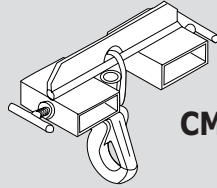

CMF

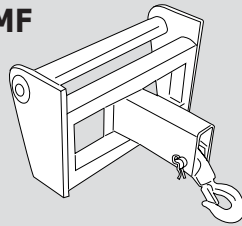

PC

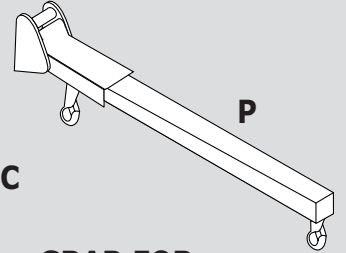

P

HYDRAULIC WINCH

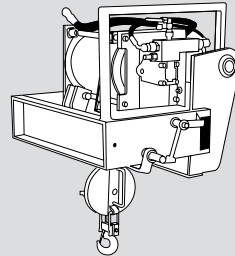

GRAB FOR SCRAP METAL

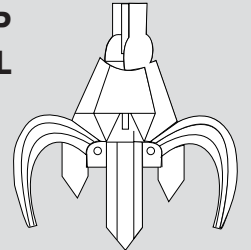

CLAMPS

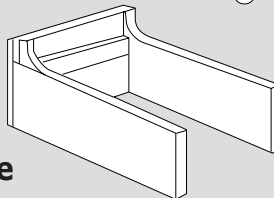

bale

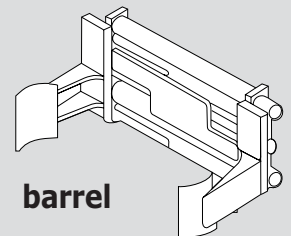

barrel

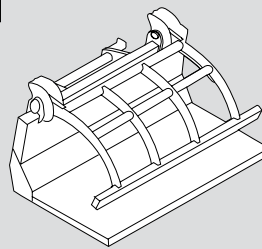

Garbage bale

WASTE BUCKET

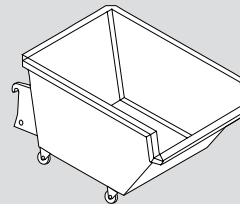

SIDE SHIFT CARRIAGE

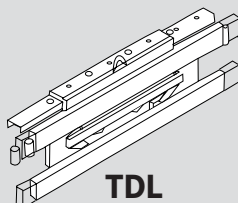

TDL

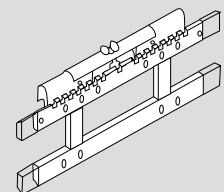

Standard TDL





Other equipment

FORK CARRIAGE AND EXTENSION

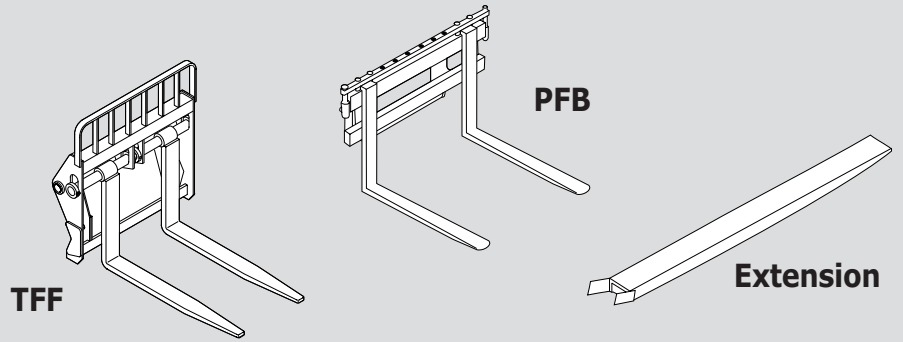

AERIAL WORK PLATFORM (for compatible models)

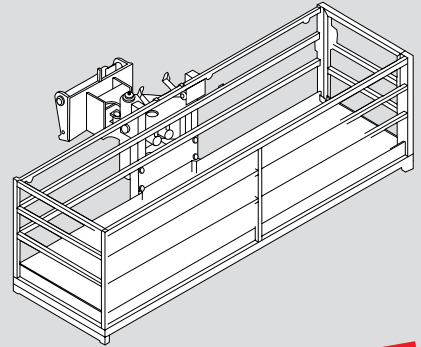

ROAD SWEEPER

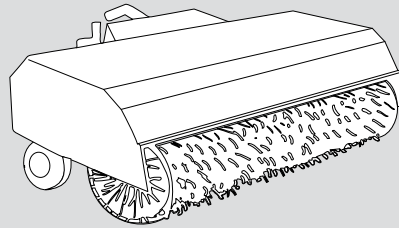

**OTHER EQUIPMENT
CUSTOMISED TO ORDER**

EARTHMOVING HOE

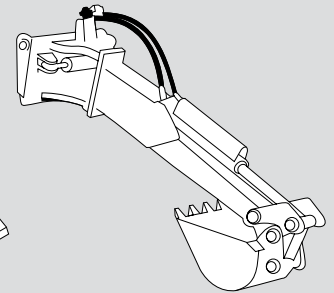

EARTHMOVING BLADE

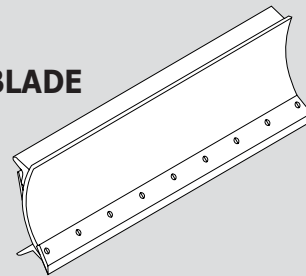

HYDRAULIC PICK-UP HITCH

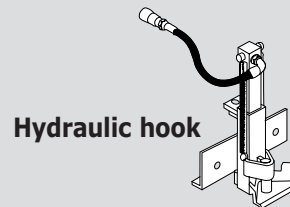

Adjustable hook

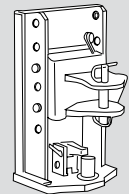

ELECTRONIC FITTINGS Hydraulic and electric

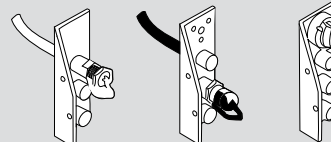

Braking and tilting bucket

Trailer lighting

Manitou, material handling world leader

Inventor of the rough terrain forklift truck, Manitou offers today the most comprehensive range to meet all specific handling and personal lifting requirements :



Telescopic trucks
MANISCOPIC

Rough terrain and semi industrial masted trucks
MANITOU



Access equipment
MANIACCESS

Compact telescopic handler
Twisco

Truck mounted forklifts
MANITRANSIT



Backhoe/Loader with telescopic boom
MANIHOE



Swinging arm and articulated wheeled loaders
MANILOADER



Electric pallet trucks and electric stackers
MANILEC



A network of skilled professionals at your service

With a network of 500 service and parts centres in more than 100 countries, Manitou provides an efficient after-sales support based on the expertise of 2000 factory trained technicians.

This publication in no way constitutes an offer and the company reserves the right to alter specification without prior notice. The MANITOU models presented in this brochure can be supplied complete with optional equipment attachments.

MANITOU BF SA

B.P. 249 - 44158 Ancenis Cedex - France
Tél. : 33 2 40 09 10 11 / Export Department Fax : 33 2 40 09 10 97
www.manitou.com

700088EN

 **MANITOU**